



COMPACT SCP

Installation & Maintenance

Installation Instructions

1.0 General

- 1.1 It is important these Installation and Maintenance Instructions are fully adhered to.
- 1.2 Full details of the unit supplied are shown on the product nameplate. If in doubt about any detail contact Elta Fans Ltd or its agents for clarification.
- 1.3 All electrical installation must be carried out by suitably qualified and competent personnel in accordance with all current statutory requirements.
- 1.4 These instructions cover only the Elta Fans Ltd product and do not include the supply or installation of any safety equipment that may be required e.g. adequate guarding or protection from rotating parts and proper electrical isolation.
- 1.5 Any declarations made by Elta Fans Ltd about product installation and safety, are dependant on the fan equipment being used within installations which themselves meet the requirements of the relevant Standards and Directives of your region.
- 1.6 The fan is designed for use in an ambient temperature of -20°C up to a maximum of +70°C, speed controlled operating temperatures of -20°C and +50°C and up to 95% relative humidity. EC fans are designed for ambient temperatures up to +60°C. The fan is not suitable for corrosive or explosive atmospheres.
- 1.7 The installer should provide easy access to the fan to facilitate future maintenance.
- 1.8 The installer should ensure the fan is adequately supported.
- 1.9 This product is not intended for use by persons (including children) with reduced physical, sensory or mental capabilities, or lack of experience and knowledge, unless they have been given supervision or instruction concerning use of the product by a person responsible for their safety. Children should be supervised to ensure that they do not play with the product.
- 1.10 At end-of-life, the unit must be disposed of in an environmentally friendly manner by suitably qualified and competent personnel in accordance with the requirements of applicable Standards and Directives.

2.0 Installation

WARNING – The fan must be isolated from the power supply during installation and maintenance. The fan must be earthed in accordance with the local regulations.

- 2.1 Upon receipt, the fan equipment should be visually inspected to check for any damage. Ensure that the impeller is free to rotate.
- 2.2 If there are any queries concerning the fan equipment, Elta Fans Ltd should be contacted prior to the installation.
- 2.3 The fan must be securely mounted in the desired position to suit the application. The fan can be mounted at any angle.
- 2.4 Check the details on the motor rating plate to ensure that the correct power supply (voltage, frequency and phase) is available. An incorrect power supply will lead to permanent damage to the fan motor.
- 2.5 Refer to the appropriate wiring diagram. Ensure that all earth connections are made.
- 2.6 Means for electrical disconnection must be incorporated in the wiring installation in accordance with the relevant wiring and electrical regulations.
- 2.7 Precaution must be taken to locate the exhaust discharge terminal so as to avoid the backflow of gases into the room from the open flue of gas or other fuel burning appliances.

3.0 Start Up

WARNING – It is not good for any fan motor, for the user to use the power supply isolator to a fan as a means of day to day control. This can reduce the life expectancy of the fan motor and may even lead to motor failure unlikely to be covered under our warranty. The power supply isolator should only be used as a means of isolation of the power supply for maintenance and servicing requirements. Day to day control should be provided to the user by means of one of the various type of control options as per the wiring diagrams which follow in this document.

To help protect our fan motors, there is a delayed start function when the mains power is switched off at the isolator. A period of at least 5 minutes should be allowed between power disconnection and reconnection. If the user is determined to switch the fan on and off at the power supply isolator then the installer must advise the user of this motor protection function so that they wait the necessary period of up to 5 minutes between switching on and off.

WARNING – When switching off mains power for maintenance / servicing, High voltages are present at the terminals and within the motor for up to 10 minutes after disconnection of the electrical supply.

- 3.1 Before power is supplied to the unit, check that the wiring is correct as per the fan connection diagram.
- 3.2 At initial start-up, check that impeller rotation and airflow direction is correct.
- 3.3 Check that the motor amperage draw does not exceed the nameplate rating.
EC fans only:
- 3.4 Minimum interval between consecutive starts: 5 minutes.
- 3.5 Maximum 1 connection from power supply cycle per 5 minutes.

COMPACT SCP



Installation Instructions

4.0 Fan Maintenance

- 4.1 Inspection of the fan at least once every 12 months is recommended to ensure that the motor, fan blades, and supporting guards, are clean. Any build up of dust and deposits on the blades or guards should be removed using a non-abrasive cleaner.
- 4.2 All fastenings should be checked for tightness. In addition, all rotating items should be checked.
- 4.3 Bearings are of the 'sealed for life' type and will not need a detailed inspection.

WARNING – Fuses/circuit breakers are used to provide short circuit protection only. A starter panel with overload protection should be used to protect the motor.

EC Fans Only: These fans are fitted with an auto-reset thermal contact which switches the fan off in the event of a fault condition. Once the motor cools down the fan may start unexpectedly.

Only a suitably qualified and competent person may carry out maintenance after the electrical supply has been isolated.

5.0 Guarantee

Elta Fans Ltd will, free of charge, within a period of 1 year from the date of dispatch from their works, repair or at its option replace any goods which are proved to have defects as a result of defective materials or workmanship. The goods MUST be returned to Elta Fans Ltd carriage paid for examination.

COMPACT SCP



Installation Instructions

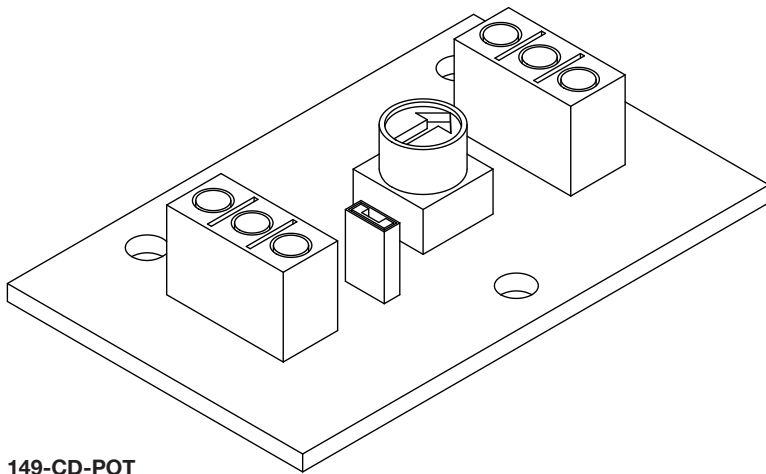

149-CD-POT

Level / Speed	OHMS (Ω)
10	10 (Ω)
9	9 (Ω)
8	8 (Ω)
7	7 (Ω)
6	6 (Ω)
5	5 (Ω)
4	4 (Ω)
3	3 (Ω)
2	1.5 (Ω)
1	500 (Ω)
0	1 (Ω)

Please note: This is an estimated adjustment guide

149-CD-POT

The 149-CD-POT is a commissioning device designed to be used with our EC range of fans.

The device will allow the for the installer to set the maximum operating speed of the fan that it is connected to.

The installer or commissioning engineer can adjust the fan speed using the potentiometer built onto the 149-CD-POT board.

This potentiometer can either be used for single speed adjustment or to set a maximum speed for the fan to operate at when an external control source is used.

If external speed control is required, the jumper connection next to the potentiometer on the board would need to be removed, the installer can then connect to ST1 (using the diagram provided).

When an external speed control is fitted, the maximum speed setting available to the external control is limited by the potentiometer setting of the commissioning device.

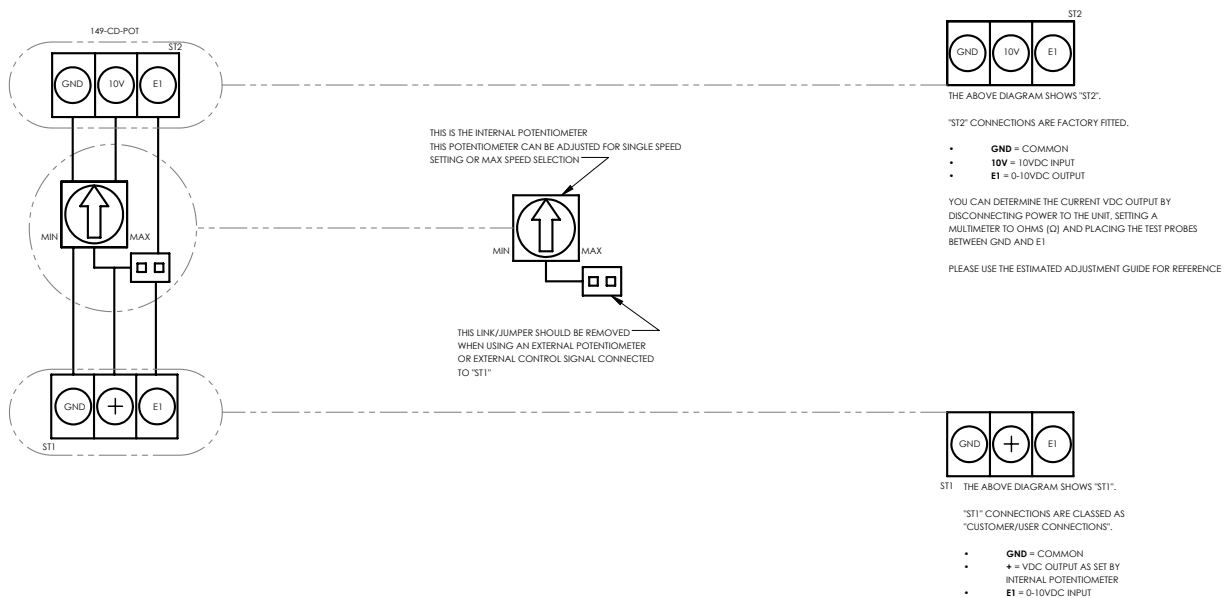

All wiring and control equipment must comply to the latest IEE regulations, in particular part 552-01-02/03.

149-CD-POT Issue A: 10.07.2018

Check the individual product accessories table for fan controller compatibility.

COMPACT SCP



Wiring Diagrams

Please use the table(s) below to match up the product code and the wiring diagram number.

Single Phase 220V to 240V / 50Hz

Page No.	Product Code	Wiring Diagram No.
6	SCP250/4-1AC	152-500
6	SCP315/4-1AC	152-500
6	SCP350/4-1AC	152-500
6	SCP500/4-1AC	152-500
6	SCP560/4-1AC	152-500
6	SCP630/4-1AC	152-500

Three Phase 380V - 415V / 50Hz

Page No.	Product Code	Wiring Diagram No.
7	SCP250/4-3AC	152-611
7	SCP315/4-3AC	152-611
7	SCP350/4-3AC	152-611
7	SCP400/4-3AC	152-611
7	SCP450/4-3AC	152-611
7	SCP450/4B-3AC	152-611
7	SCP500/4-3AC	152-611
8	SCP500/6-3AC	152-608
7	SCP560/4-3AC	152-611
8	SCP560/6-3AC	152-608
7	SCP630/4-3AC	152-611
8	SCP630/6-3AC	152-608
9	SCP710/4/6-3AC	152-614
9	SCP710/6/8-3AC	152-614
9	SCP800/6/8-3AC	152-614

COMPACT SCP



Wiring Diagrams

Please use the table(s) below to match up the product code and the wiring diagram number.

Single Phase 220V - 277V / 50Hz or 60Hz

Page No.	Product Code	Wiring Diagram No.
10	SCP250-1EC	152-711
10	SCP315-1EC	152-711
10	SCP350-1EC	152-711
10	SCP400-1EC	152-711
10	SCP450-1EC	152-711
10	SCP500-1EC	152-711
10	SCP560-1EC	152-711
10	SCP630-1EC	152-711
10	SCP710-1EC	152-711

152-500

Wiring Diagrams

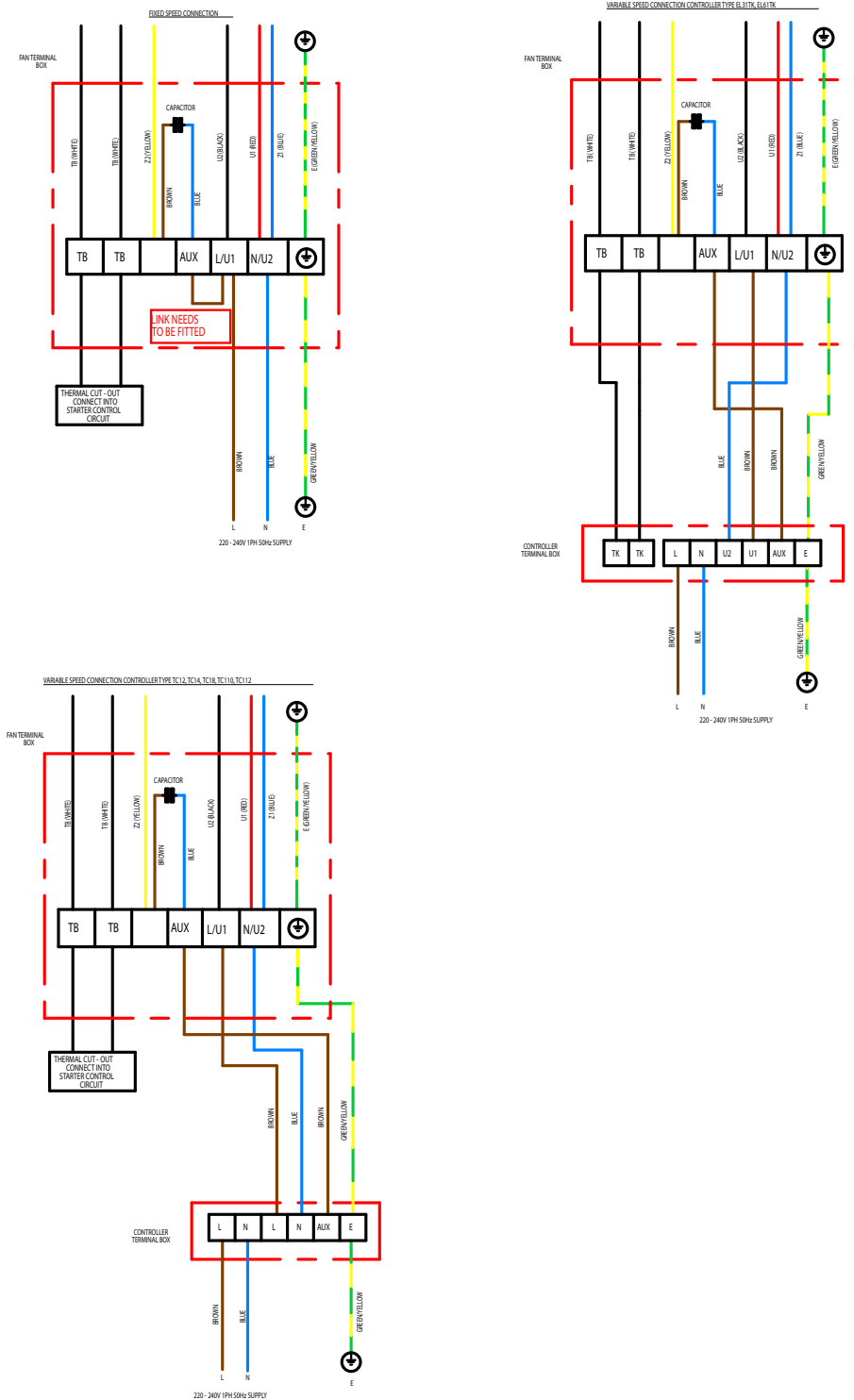

All wiring and control equipment must comply to the latest IEE regulations, in particular part 552-01-02/03.
 MK-152-500 Issue E: 02.03.2015
 Check the individual product accessories table for fan controller compatibility.

152-611

Wiring Diagrams

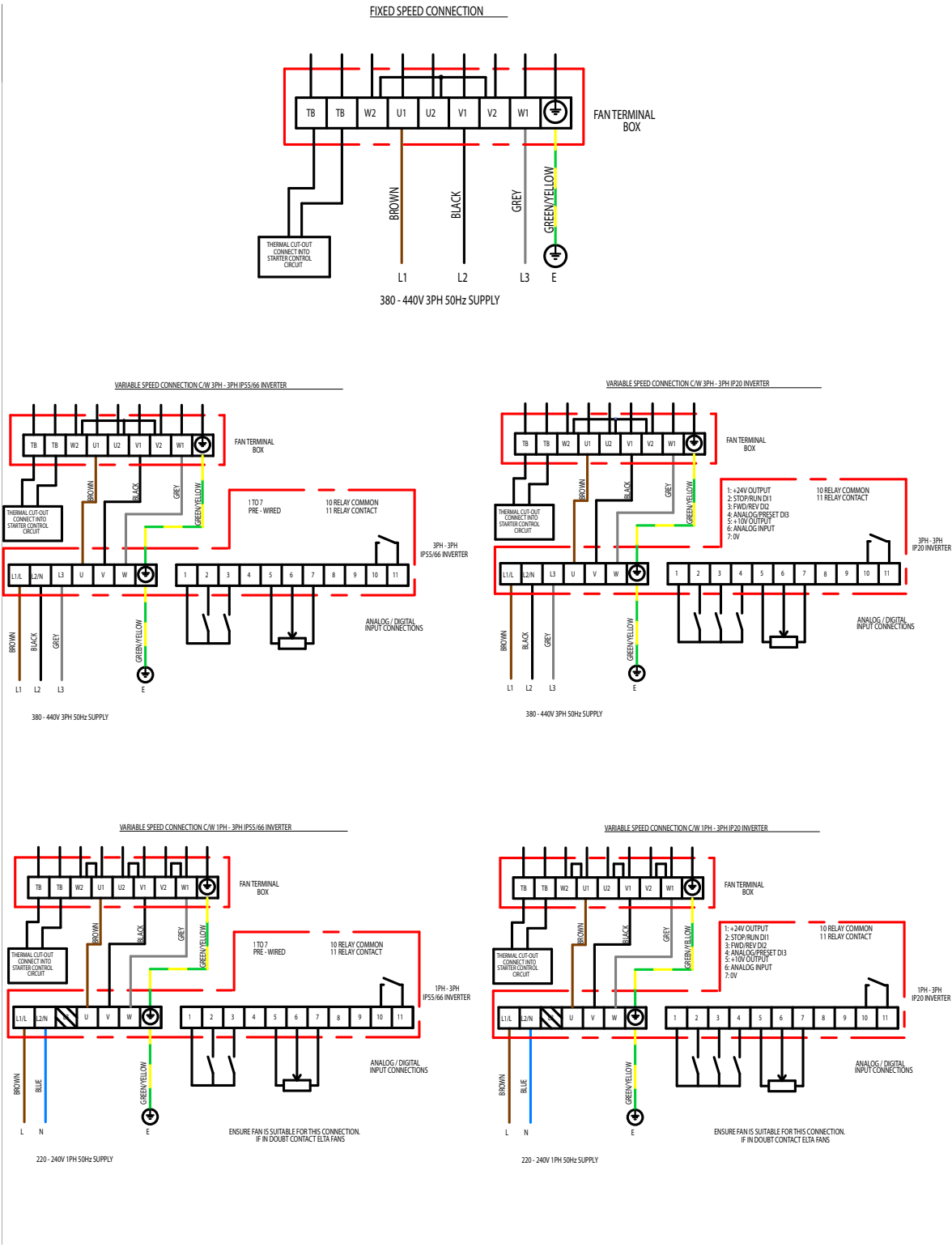

All wiring and control equipment must comply to the latest IEE regulations, in particular part 552-01-02/03.
 MK-152-611 Issue C: 21.05.2015
 Check the individual product accessories table for fan controller compatibility.

152-608

Wiring Diagrams



FIXED SPEED CONNECTION

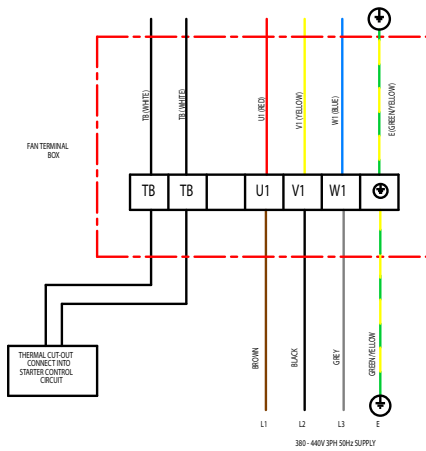

VARIABLE SPEED CONNECTION CONTROLLER TYPE TC-31, TC-32, TC-310

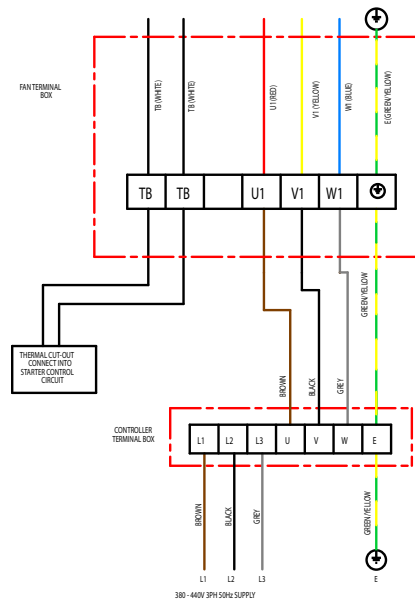

VARIABLE SPEED CONNECTION CONTROLLER TYPE 3PH - 3PH IP55 INVERTER

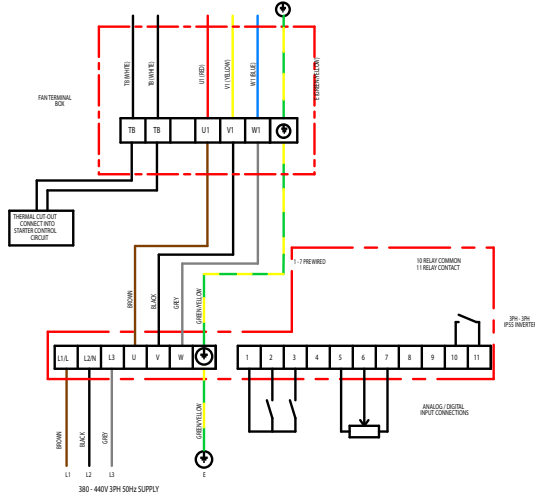

VARIABLE SPEED CONNECTION CONTROLLER TYPE 3PH - 3PH IP20 INVERTER

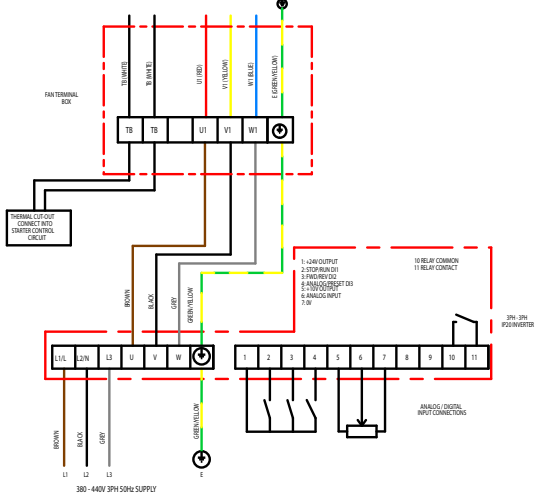

All wiring and control equipment must comply to the latest IEE regulations, in particular part 552-01-02/03.
 MK-152-608 Issue E: 21.06.2018
 Check the individual product accessories table for fan controller compatibility.

152-614

Wiring Diagrams

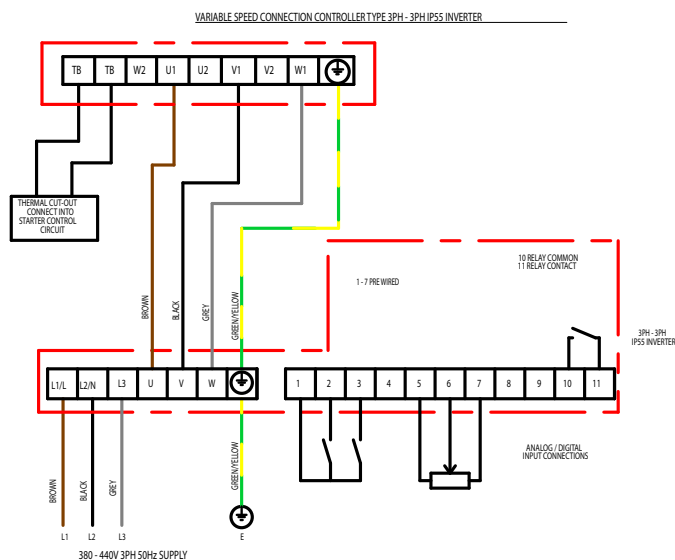
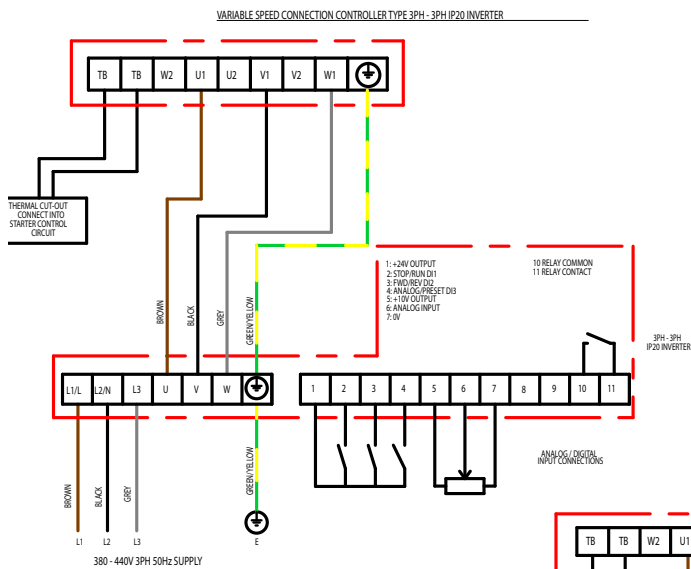
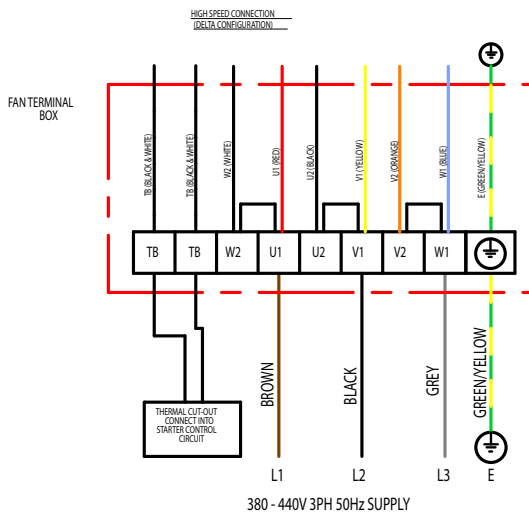
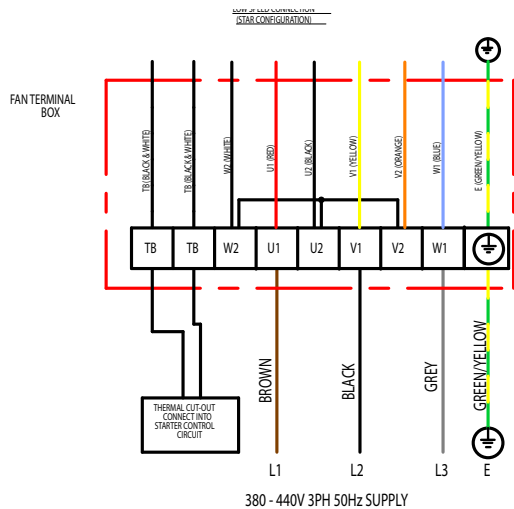

All wiring and control equipment must comply to the latest IEE regulations, in particular part 552-01-02/03.
 MK-152-614 Issue B: 29.04.2015
 Check the individual product accessories table for fan controller compatibility.

152-711

Wiring Diagrams

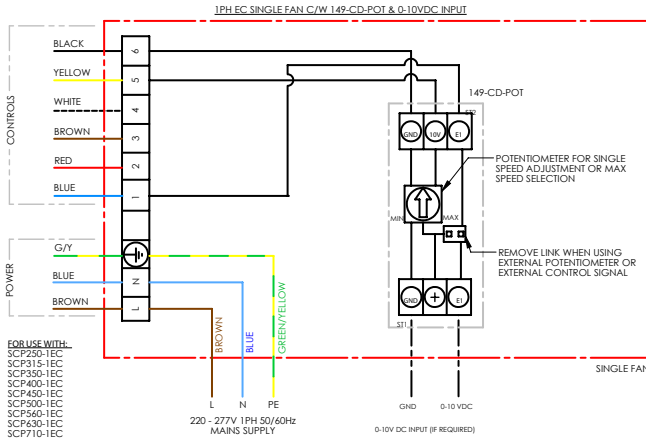
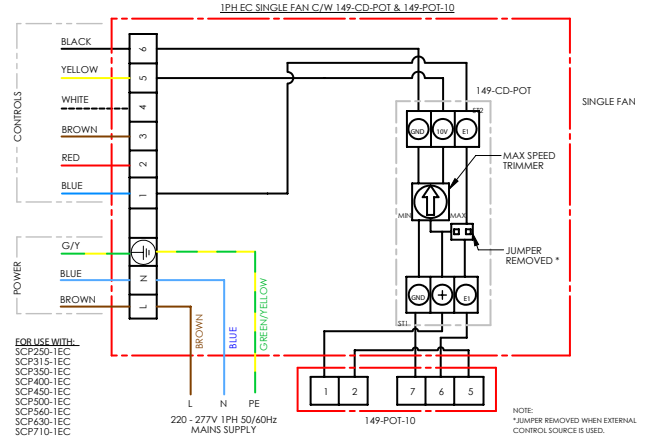
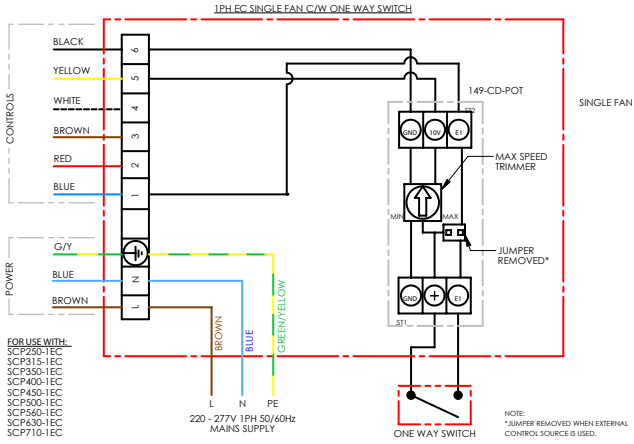

CONTROL CABLE LENGTHS	
Control Type	Max. Length
VDC (voltage control)	10m
PWM (Frequency)	10m
DC Current	300m (UL 1015 18AWG)
Speed Feedback	10m
External Controller	10m

NOTE: TAG REFERENCES RELATE TO MOTOR CONTROL WIRES, AND NOT 149-POT-10

Tag	Purpose	Description
L	Live	Live power supply, 220-277V
N	Neutral	Neutral from power supply
⊕	Permanent Earth	Permanent earth from power supply
1	DC Voltage [2-10V]	DC control voltage input [2 to 10VDC input]
2	DC Current [4-20mA]	DC control current input [4 to 20mA input]
3	Frequency [10-95%]	Frequency duty-cycle (PWM) Voltage: 10 to 24Vpk Frequency: 80Hz (10 to 95% input)
4	Speed Reference	Tacho output
5	10VDC output	10VDC source output
6	GND / Common	DC Common

ALL WIRING AND CONTROLS EQUIPMENT MUST COMPLY TO THE LATEST IET REGULATIONS, IN PARTICULAR PART 552-01-02/03

All wiring and control equipment must comply to the latest IEE regulations, in particular part 552-01-02/03.

MK-152-711 Issue F: 10.02.2022

Check the individual product accessories table for fan controller compatibility.

Building Services

Tel **+44 (0) 1384 275800**
Fax **+44 (0) 1384 275810**
Email **bs@eltafans.co.uk**

46 Third Avenue, Pensnett Trading Estate, Kingswinford,
West Midlands, DY6 7US United Kingdom

Applied Technology & Building Services Export

Tel **+44 (0) 1489 566500**
Fax **+44 (0) 1489 566555**
Email **at@eltafans.co.uk / export@eltafans.co.uk**

17 Barnes Wallis Road, Segensworth East Industrial Estate,
Fareham, Hampshire, PO15 5ST United Kingdom

eltafans.com

535-IOM0015 Issue G



BS EN ISO 9001:2015 FM 556465

